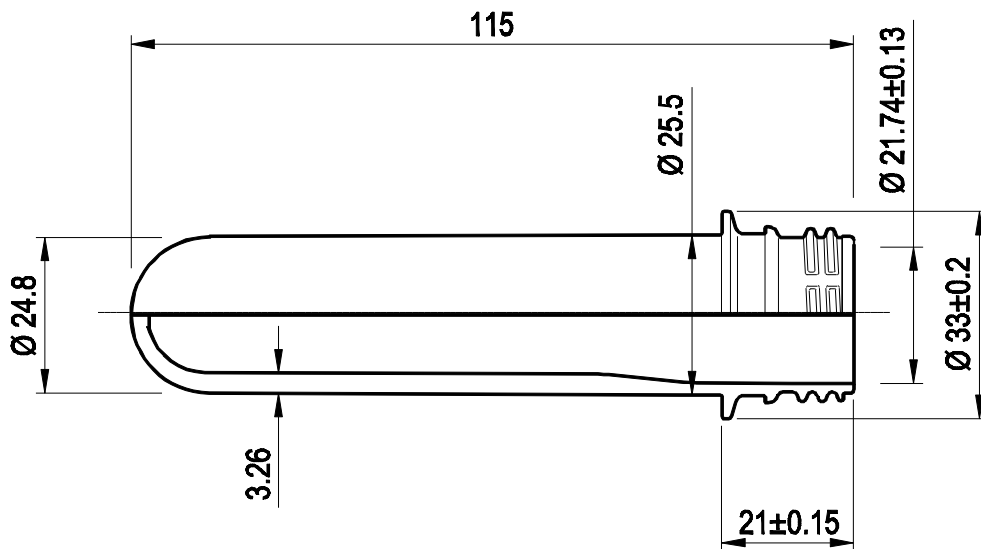

PET Preforms

 Visit our Web Site at [Http://www.resilux.com](http://www.resilux.com)
Product Reference
P315T6

Product Range	Carbonated Drinks
Weight	31,5 gr
Neck-Finish	Standard PCO

For further information about this product, please feel free to contact our sales people / agencies.

The content of this document is provided purely for information purposes and does not, under any circumstances, constitute a business proposal or investment advice relating to the shares of RESILUX NV or its group companies.